

INSTALLATION GUIDE

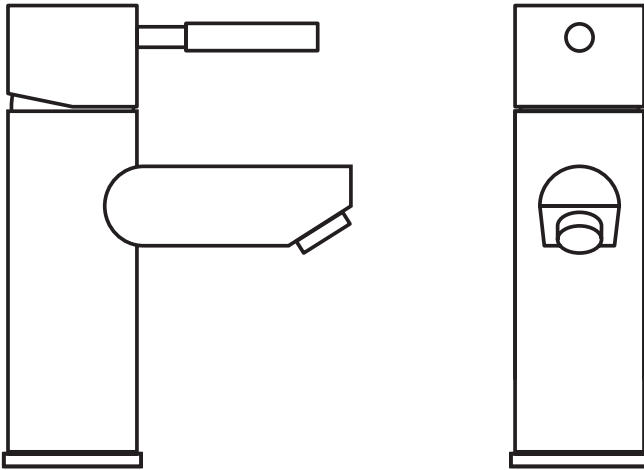

INSTALLATION GUIDE

Remove the unit from its packaging. Before disposing of packaging and taking unit from your salesperson, inspect the unit.

Should inspection reveal any damage or defects in the finish, contact your salesperson. The warranty does not cover damages or defects in the finish once the unit has been installed.

It is recommended that you place the unit in the bathroom before you start. Sectional units should be disassembled if necessary. Conserve all nuts and bolts.

Don't over bend the hose, ensure no hose deformation before or after installation.

CAUTION: FOR BEST RESULTS, WE STRONGLY RECOMMEND THE INSTALLATION OF THIS FAUCET BE DONE BY A LICENSED PLUMBER.

CARE AND MAINTENANCE

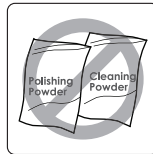

- **Avoid** polishing powder, cleaning powder and any kind of detergent.
- To clean your Valley Acrylic faucet , wash with a soapy nonabrasive cloth. Wipe dry with a soft towel or cloth. We recommend this be done on a regular basis.

AERATOR MAINTENANCE

Clean the aerator gently with a toothbrush.

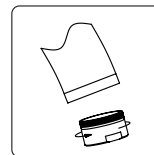
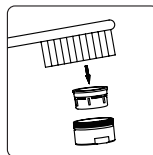
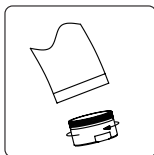



Before assembly, flush the water supply pipes thoroughly to drain debris inside (allow the water to run with the main stopcock open for 3min), otherwise dirty particles might affect the function of the faucet.

01



SHUT OFF WATER SUPPLIES

SPOUT INSTALLATION

Place spout body (1), o-ring, (2) onto countertop. Install supply lines (6), gasket (4) and washer (3). Hand tighten spout (1) with fixing nuts (5).

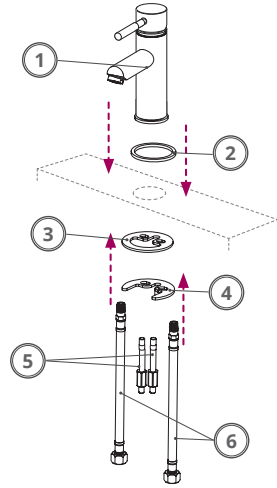

02

Attach the water lines to your main water supply. Ensure that you are connecting the hot and cold lines appropriately. The hot water inlet must always be connected on the left side and the cold water inlet on the right side.

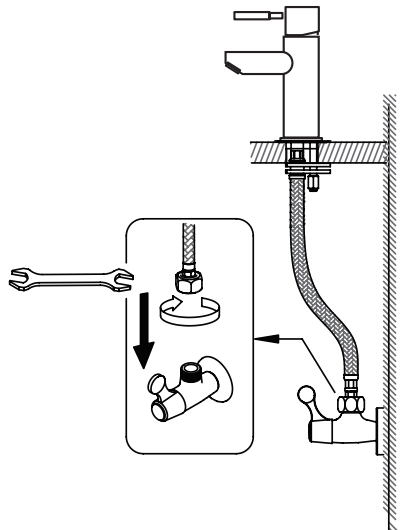

VALLEY[®]

ELEMENT COLLECTION

802.211.100

LAVATORY FAUCET



VALLEY[®]

...you dream it, we create it

Congratulations! You are now a part of the Valley Acrylic family.