





Product images are for illustration purposes only. Actual product(s) may vary.

WHITE FINISH	
MODEL No.	
2461	 LEFT HAND DRAIN LOCATION
2471	 RIGHT HAND DRAIN LOCATION

DIMENSIONS	WATER DEPTH	CAPACITY
<ul style="list-style-type: none"> Length: 60" / 1524mm Width: 34" / 864mm Skirt Height: 25" / 635mm 	17.5" / 445mm Drain to overflow	75 gal. 284 litres of water

PRODUCT INFORMATION:	
<ul style="list-style-type: none"> Modern style Plain skirt End drain Made in Canada 	<ul style="list-style-type: none"> Above floor rough-in installation High gloss / Crack-resistant acrylic Complies with CSA & IAPMO standards

SHIPPING INFORMATION:	
<ul style="list-style-type: none"> Length: 62" / 1575mm Width: 38" / 965mm Height: 26" / 660mm 	<ul style="list-style-type: none"> Net Weight: 35 kg / 77 lbs Gross Weight: 40 kg / 88 lbs

MODEL NUMBER : 2461
(LEFT HAND DRAIN LOCATION)

MODEL NUMBER : 2471
(RIGHT HAND DRAIN LOCATION)

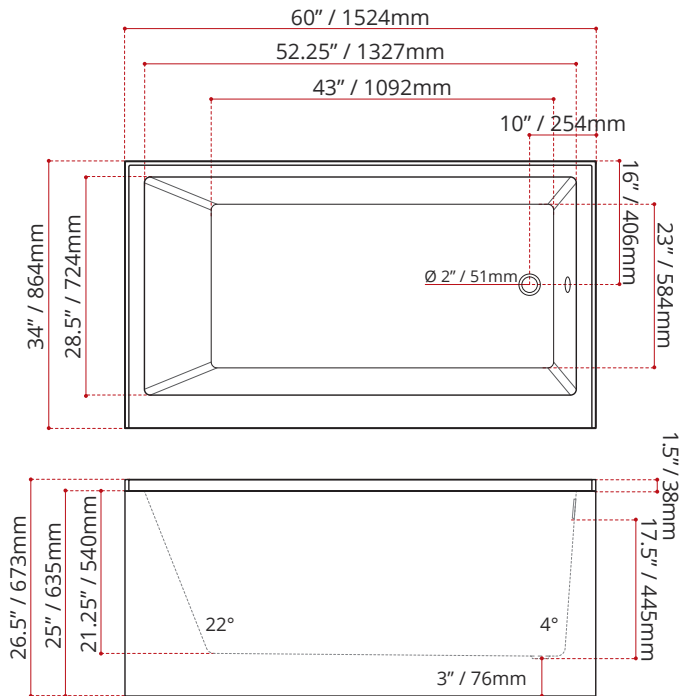
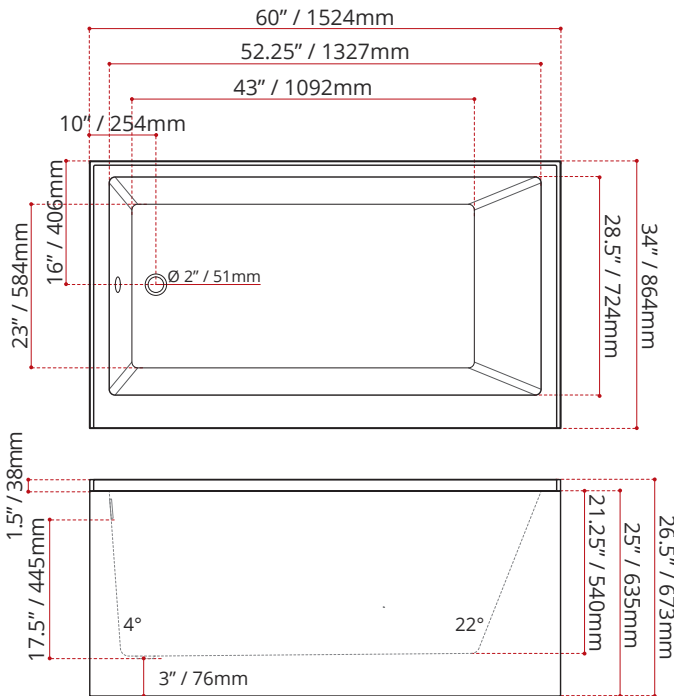

DISCLAIMER: Measurements may vary ± 1/4" (Diagram Not to scale)

CUSTOMIZE YOUR TUB

ALL UPCHARGE OPTIONS ARE MADE TO ORDER - NO REFUND - NO RETURN -

AVAILABLE CUSTOMIZATION OPTIONS	MODEL No.
3/4" SET BACK WOOD APRON	C1
WOOD APRON REMOVABLE ACCESS PANEL	C2
TEXTURED BOTTOM	C4
DOUBLE TILING FLANGE	C5
3/4" SET BACK WOOD APRON +TEXTURED BOTTOM	C14
3/4" SET BACK WOOD APRON + DOUBLE TILING FLANGE	C15
REMOVABLE ACCESS PANEL + TEXTURED BOTTOM	C24
REMOVABLE ACCESS PANEL + DOUBLE TILING FLANGE	C25
TEXTURED BOTTOM + DOUBLE TILING FLANGE	C45
3/4" SET BACK WOOD APRON + TXRED BTM + DBL TILING FLANGE	C145
REMOVABLE ACCESS PANEL + TXRED BTM + DBL TILING FLANGE	C245

JETTING OPTIONS

ALL EXPERIENCES ARE MADE TO ORDER - NO REFUND - NO RETURN -

MODEL No.	DESCRIPTION
E15	16 LATERAL AIR JETS (CHROME) + 1 ROUND LIGHT (WHITE) + 6 THIN LINE TURBO JETS (CHROME)
E33	16 AIR ILLUSION JETS + 2 ROUND LIGHTS (WHITE) + 6 STANDARD THIN LINE JETS (WHITE)
E56	16 SANTE AIR JETS (WHITE) + 1 ROUND LIGHT (WHITE) + 6 STANDARD THIN LINE JETS (WHITE)
E75	16 ZEN AIR JETS (CHROME) + 2 ROUND LIGHTS (WHITE) + 6 SQUARE STANDARD JETS (CHROME)
M16	4 V-MASSEUSE + 16 AIR ILLUSION JETS + 2 ROUND LIGHTS (WHITE)
M33	4 WHIRLPOOL V-MASSEUSE + 16 LATERAL AIR JETS (CHROME) + 1 ROUND LIGHT (WHITE)
062	6 REGULAR WHIRLPOOL WATER JETS - BRUSHED NICKEL
032	16 SANTE AIR JETS (WHITE FINISH) + 1 ROUND LIGHT (WHITE FINISH)

*FOR MORE EXPERIENCES, JETTING OPTIONS & ACCESSORIES
PLEASE REFER TO THE JETTING GUIDE*

HOW TO CREATE THE MODEL NUMBER

When configuring a bathtub please follow the correct order of the configuration options.

COLOUR OPTION + CUSTOMIZATIONS + JETTING OPTIONS

Let's break down an example — Here is Model No.

2461C45E56

2461C45E56 (PSPACEAFR6034 LEFT HAND DRAIN WHITE FINISH)

2461**C45**E56 (TEXTURED BOTTOM + DOUBLE TILING FLANGE)

2461C45**E56** (JETTING OPTION)

PSPACEAFR6034SK LEFT HAND DRAIN WHITE FINISH + TEXTURED BOTTOM + DOUBLE TILING FLANGE + 16 SANTE AIR JETS (WHITE) + 1 ROUND LIGHT (WHITE) + 6 STANDARD THIN LINE JETS (WHITE)