

APRON FIRECLAY CERAMIC BASIN INSTALLATION GUIDE

Thank you for choosing Valley Bath & Kitchen products. This installation guide provides essential information to ensure a smooth and successful installation.

BEFORE YOU BEGIN

Read all instructions: Please review the entire guide carefully before starting the installation.

Verify local building codes: Ensure that your installation complies with local building standards and regulations.

Inspect the unit: After removing the product from its packaging, carefully inspect it for any signs of damage or defects. Do not dispose of the packaging until you have verified that the unit is in perfect condition.

Report damages immediately: If you discover any damage or defects, please contact Valley Bath & Kitchen at 1-877-398-8827. **Note: The warranty does not cover damages or finish defects after installation.** Valley Bath & Kitchen's responsibility for shipping-related damages ends upon delivery to the carrier in good condition. Any transport-related damage claims should be directed to the carrier.

CAUTION

Risk of personal injury or product damage. Handle with care. The product may break, chip, or cause injury if mishandled. Always get assistance when lifting or moving the unit.

REQUIRED TOOLS:



Tape Measure



Silicone Gun

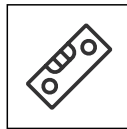

Level

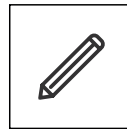

Pencil



Planer



Screwdriver

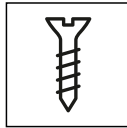

Screws

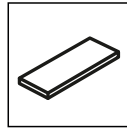

Wood Plank

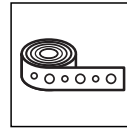

Plumbing Strap

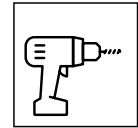

Handrill

 **BEFORE INSTALLING THIS SINK, VERIFY THE SINK MEASUREMENT.** 

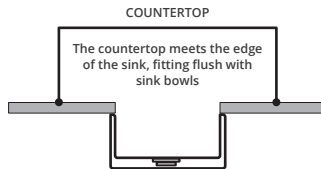
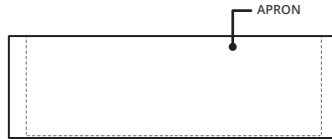
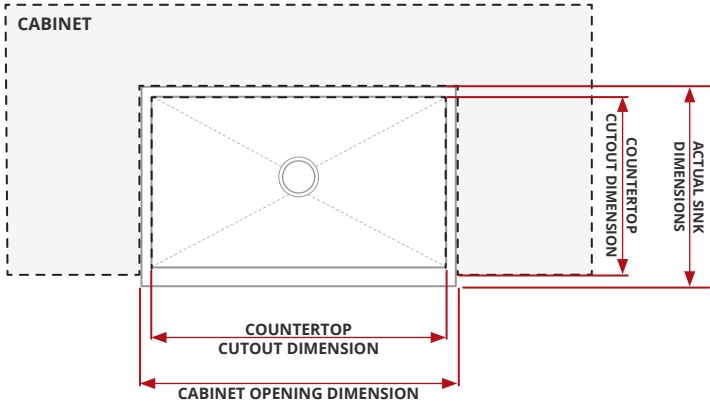

01

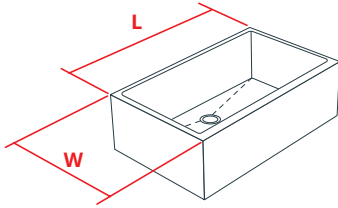

Measure the Sink Opening

Measure the exterior dimensions of the sink to ensure proper fitting.

02

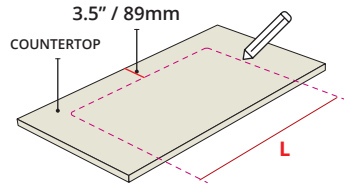

Outline the Sink

Use a pencil to trace the edge of the sink onto the countertop. Ensure there is a **minimum clearance of 3.5 inches** from the sink edge to the wall. Check whether there is enough space the space under the basin to install the supply and drain pipes.

03

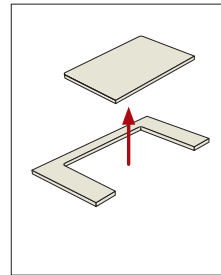
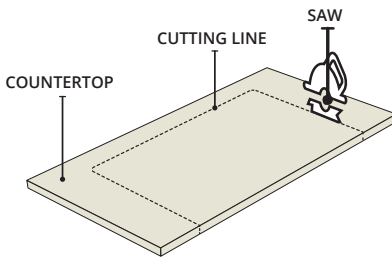

Countertop Cut out

Drill one hole inside the marked cutting line, and cut out the countertop

04

Install Support Framing



For proper countertop installation, the top of the sink must not extend above the top of the cabinet.

- Build 2x4 support framing along both inside walls of the base cabinet, ensuring the sink rim sits at or slightly below the cabinet top.
- Level and secure the framing with construction adhesive and screws (not included).
- Cut four vertical 2x4 supports from the installed framing down to the cabinet floor.
- Secure the vertical supports with construction adhesive and screws (not included).

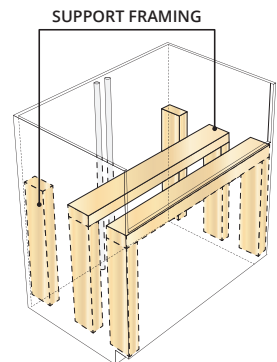

05

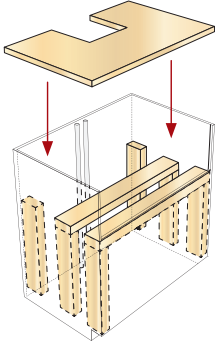

Extra Support

We recommend building a small support platform inside the cabinet for added stability. Use a 3/4" thick board wide enough to support the sink, while leaving space at the back for the plumbing to pass through

06

Back Support Framing

Use 2x4s to build vertical support framing from the support platform up to the top of the cabinet frame for added back support

BACK SUPPORT FRAMING

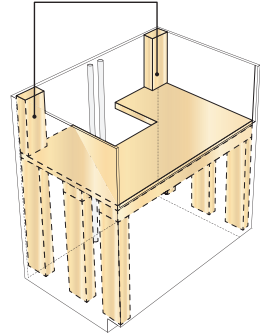

07

Install the Kitchen Sink

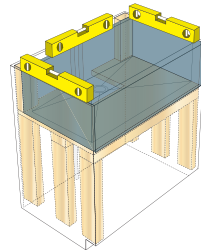
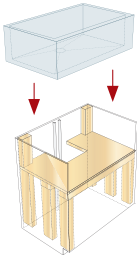

1.1 Carefully lower the sink into the cabinet and ensure it is fully supported by the framing.

1.1 Check that the sink is level. Adjust as needed and use shims if necessary.

08

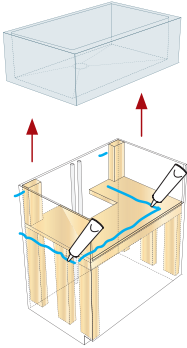

Remove the sink from the cabinet to expose the support framing.

Apply a continuous bead of 100% silicone sealant along the top surface of each support.

09

Carefully lower the sink onto the supports, pressing it into place so the apron sits flush with the front of the cabinet.

Apply a continuous bead of 100% silicone sealant along the sides and back edges of the sink as shown.

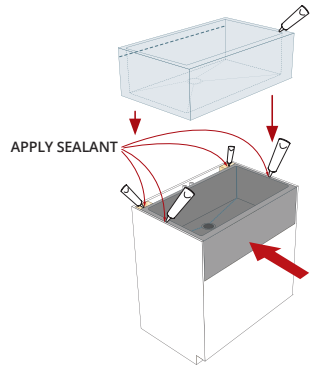

10

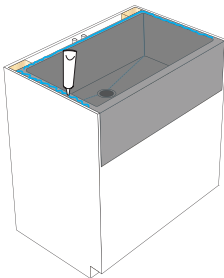

Apply a continuous bead of 100% silicone sealant along the top rim on three sides, as shown.

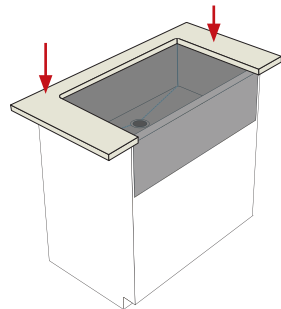

Install the countertop

11

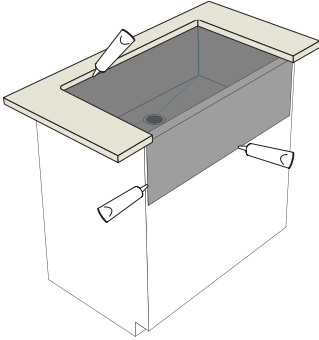

Apply a thin, continuous bead of 100% silicone sealant along the joint where the sink meets the countertop and cabinet.

 **IMMEDIATELY WIPE AWAY
ANY EXCESS SEALANT.** 

**24
HRS**



***PLEASE ALLOW 24 HOURS FOR THE SILICONE TO
FULLY CURE BEFORE USING THE KITCHEN SINK.***

WARRANTY INFORMATION:

These products have a limited warranty for residential use for a period of up to 1 year from the original purchase date, against any failure from improper manufacturing defects.

Congratulations! You are now a part of the Valley Bath & Kitchen family, and an owner of a great product!