



Product images are for illustration purposes only. Actual product(s) may vary.

DESCRIPTION:

- Above counter Shila Stone basin
- Default finish White (Matte or Gloss)
- White linear drain cover included
- No overflow
- Drain assembly sold separately
- Wall-mount option available
- Stain, scratch and crack resistance
- Fabricated in Canada
- Complies with CSA & IAPMO standards

DEFAULT FINISHES

MW
MATTE WHITE
(2516MW)

GW
GLOSS WHITE
(2516GW)

CUSTOM FINISHES

(GLOSS FINISH ONLY)

Colour Me SERIES

MARBLE SERIES

Flake Series

SHIPPING INFORMATION:

- Length: 26" / 660mm
- Net Weight: 24 kg / 52 lbs.
- Width: 18" / 457mm
- Gross Weight: 26 kg / 57 lbs.
- Height: 9" / 229mm

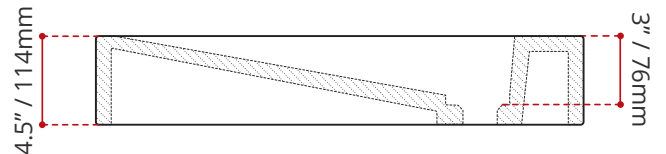
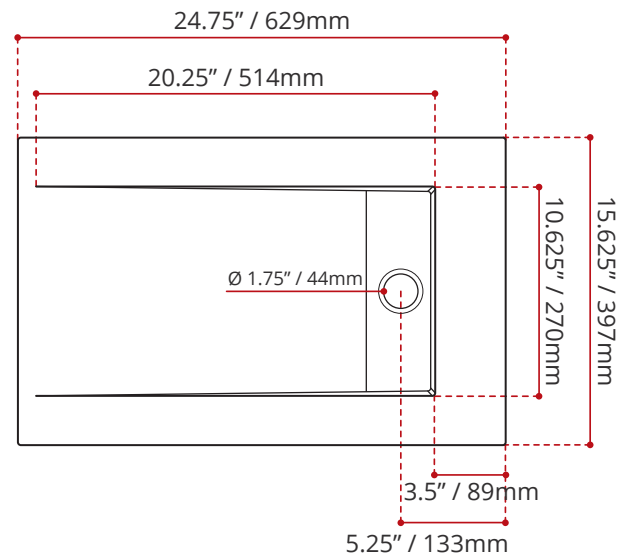

DISCLAIMER: Measurements may vary ± ¼" (Diagram Not to scale)

BASIN VARIATIONS

ALL UPCHARGE OPTIONS ARE MADE TO ORDER - NO REFUND - NO RETURN -

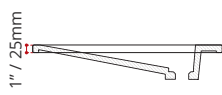
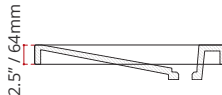
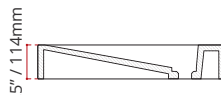
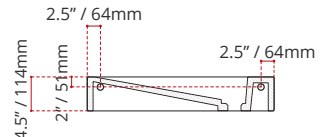
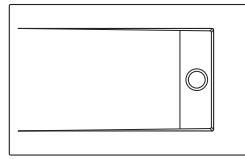
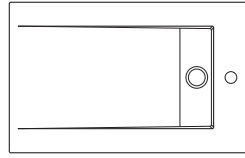
2516W		LIP SIZE OPTIONS			WALL MOUNT	
		1" LIP Drop-In Cutting Required 	2.5" LIP Drop-In Cutting Required 	4.5" LIP Vessel Drain portion Cutting Required 	WM 	
FAUCET HOLE DRILLING OPTIONS	NH NO HOLE 	(MATTE WHITE FINISH)	2516MW1-NH	2516MW25-NH	2516MW45-NH	R RIGHT HAND DRAIN 2516MW45WMR-NH
		(GLOSS WHITE FINISH)	2516GW1-NH	2516GW25-NH	2516GW45-NH	L LEFT HAND DRAIN 2516MW45WML-NH
	1H 1 HOLE 	(MATTE WHITE FINISH)	2516MW1-1H	2516MW25-1H	2516MW45-1H	R RIGHT HAND DRAIN 2516MW45WMR-1H
		(GLOSS WHITE FINISH)	2516GW1-1H	2516GW25-1H	2516GW45-1H	L LEFT HAND DRAIN 2516MW45WML-1H
		(MATTE WHITE FINISH)	2516MW1-1H	2516MW25-1H	2516MW45-1H	R RIGHT HAND DRAIN 2516GW45WMR-1H
		(GLOSS WHITE FINISH)	2516GW1-1H	2516GW25-1H	2516GW45-1H	L LEFT HAND DRAIN 2516GW45WML-1H