





MODEL No.	FINISH	 ENVIRO SEAL
<b>1175</b> LEFT HAND DRAIN LOCATION 	 <b>MATTE BLACK</b>	
<b>1185</b> RIGHT HAND DRAIN LOCATION 		

DIMENSIONS	WATER DEPTH	CAPACITY
<ul style="list-style-type: none"> <li>Length: 60" / 1524mm</li> <li>Width: 32" / 762mm</li> <li>Skirt Height: 24" / 610mm</li> </ul>	17.625" / 448mm Drain to overflow	51 gal. 194 litres of water

**PRODUCT INFORMATION:**

Shila Stone is highly resistant to staining and chemical cleaners. Moreover, its non-porous, bacteriostatic surface limits the growth of microorganisms, making it a perfectly hygienic material.

- Modern style
- Plain skirt
- End drain
- Made in Canada
- Hygienic material
- Made from Shila Stone cast resin**
- Stain, scratch and crack resistance
- Complies with CSA & IAPMO standards

**SHIPPING INFORMATION:**



- Length: 62" / 1575mm
- Width: 34" / 864mm
- Height: 26" / 660mm



- Net Weight: 35 kg / 77 lbs
- Gross Weight: 40 kg / 88 lbs

MODEL NUMBER : **1175**  
(LEFT HAND DRAIN LOCATION)

MODEL NUMBER : **1185**  
(RIGHT HAND DRAIN LOCATION)

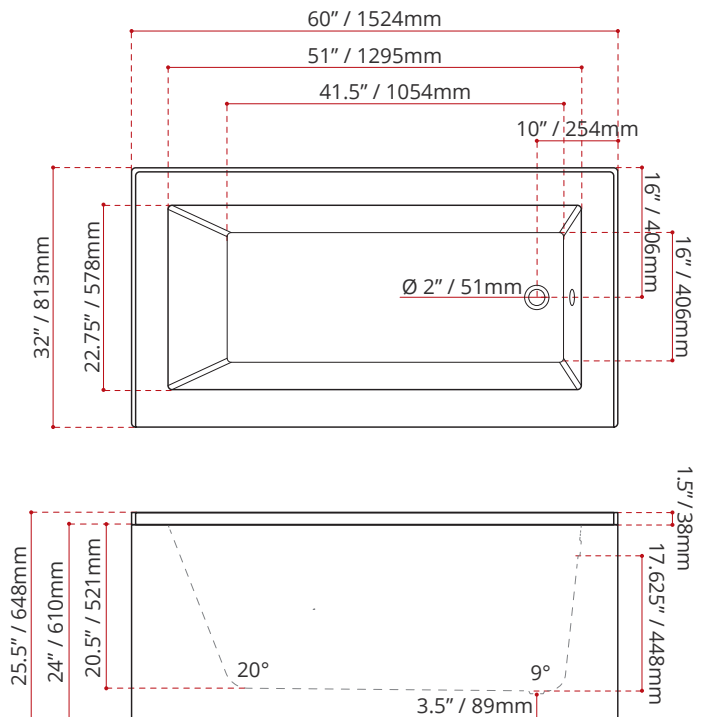
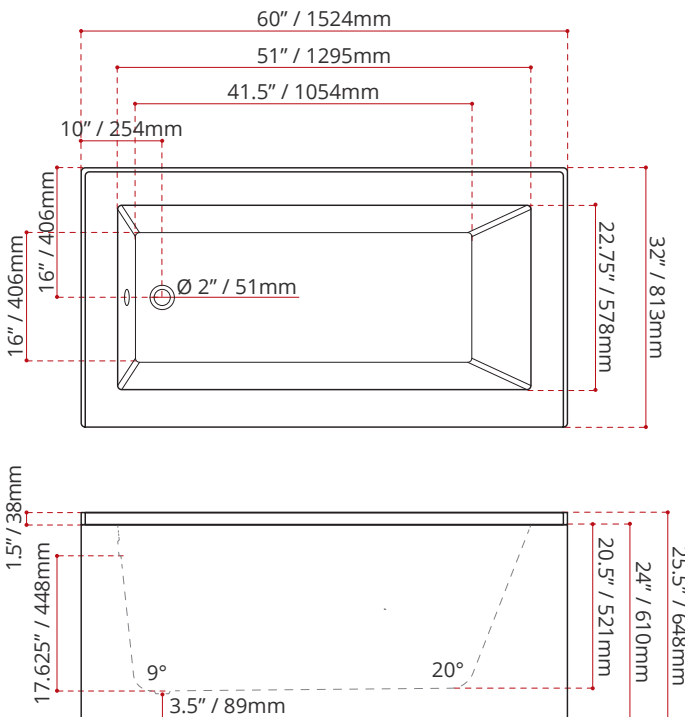

DISCLAIMER: Measurements may vary ± 1/4" (Diagram Not to scale)

