





Product images are for illustration purposes only. Actual product(s) may vary.

COLOUR OPTIONS ARE MADE TO ORDER - NO REFUND - NO RETURN -

BLACK FINISH

MODEL No: SSTCD48322

BISCUIT FINISH

MODEL No: SSTCD48323

Valley's single threshold, center drain acrylic shower bases are meant to be installed in an alcove setting. Valley's acrylic shower bases are fabricated at our facility in Mission, BC (Canada) out of high gloss, crack-resistant acrylic.

DESCRIPTION:
<ul style="list-style-type: none"> • Single Threshold / Opening • White Finish • Center Drain • High gloss / Crack-resistant acrylic. • Made in Canada. • Complies with CSA & IAPMO standards.

CUSTOMIZE YOUR SHOWER BASE

ALL UPCHARGE OPTIONS ARE MADE TO ORDER - NO REFUND - NO RETURN -

AVAILABLE CUSTOMIZATION OPTIONS	MODEL No.
TEXTURED BOTTOM	C4
DOUBLE TILING FLANGE	C5
TEXTURED BOTTOM + DOUBLE TILING FLANGE	C45

SHIPPING INFORMATION:
<ul style="list-style-type: none"> • Length: 50" / 1270mm • Width: 34" / 864mm • Height: 8" / 203mm • Net Weight: 23 kg / 51lbs • Gross Weight: 25 kg / 55lbs

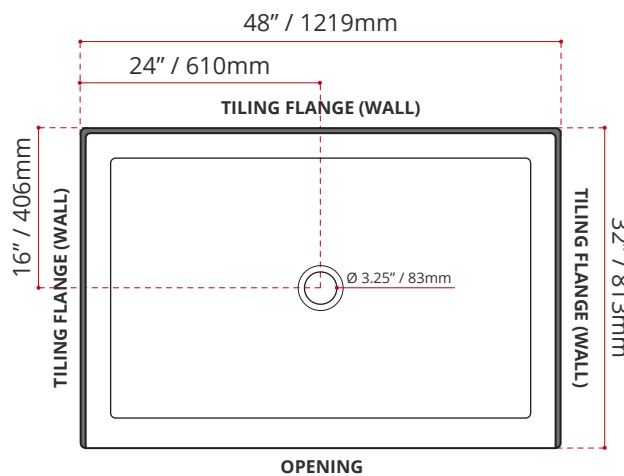

DISCLAIMER: Measurements may vary ± 1/4" (Diagram Not to scale)

