



COLOUR OPTIONS ARE MADE TO ORDER - NO REFUND - NO RETURN -

BLACK FINISH
MODEL No: SSTLD7236L2 (LEFT HAND DRAIN)
MODEL No: SSTLD7236R2 (RIGHT HAND DRAIN)

BISCUIT FINISH
MODEL No: SSTLD7236L3 (LEFT HAND DRAIN)
MODEL No: SSTLD7236R3 (RIGHT HAND DRAIN)

Valley's single threshold, offset linear drain acrylic shower bases are meant to be installed in an alcove setting. A white drain cover is included with every purchase. Valley's acrylic shower bases are made out of high gloss, crack-resistant acrylic.

DESCRIPTION:
<ul style="list-style-type: none"> • Single Threshold / Opening • White finish • Off-set Drain location • Default white linear drain cover included • High gloss / Crack-resistant acrylic • Made in Canada • Complies with CSA & IAPMO standards.

CUSTOMIZE YOUR SHOWER BASE

ALL UPCHARGE OPTIONS ARE MADE TO ORDER - NO REFUND - NO RETURN -

AVAILABLE CUSTOMIZATION OPTIONS	MODEL No.
TEXTURED BOTTOM	C4
DOUBLE TILING FLANGE	C5
TEXTURED BOTTOM + DOUBLE TILING FLANGE	C45

SHIPPING INFORMATION:
<ul style="list-style-type: none"> • Length: 74" / 1880mm • Width: 38" / 965mm • Height: 8" / 203mm • Net Weight: 35 kg / 77lbs • Gross Weight: 40 kg / 88lbs

SSTLD7236L1
(LEFT HAND DRAIN LOCATION)

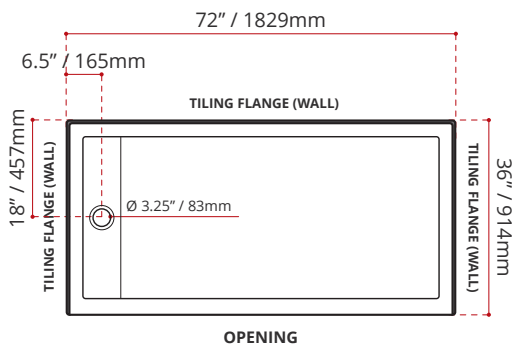

SSTLD7236R1
(RIGHT HAND DRAIN LOCATION)

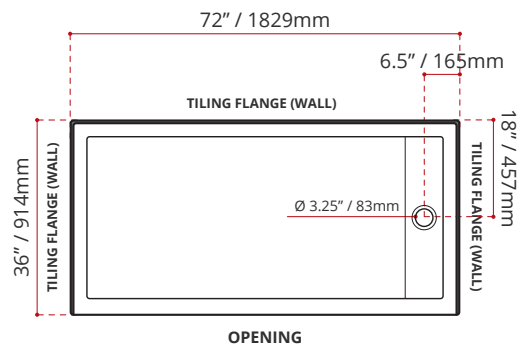

DISCLAIMER: Measurements may vary ±1/4" (Diagram Not to scale)

