



COLOUR OPTIONS ARE MADE TO ORDER - NO REFUND - NO RETURN -

BLACK FINISH
MODEL No: SSTOD6630L2 (LEFT HAND DRAIN)
MODEL No: SSTOD6630R2 (RIGHT HAND DRAIN)

BISCUIT FINISH
MODEL No: SSTOD6630L3 (LEFT HAND DRAIN)
MODEL No: SSTOD6630R3 (RIGHT HAND DRAIN)

Valley's single threshold, offset drain acrylic shower bases are meant to be installed in an alcove setting. All acrylic shower bases have been redesigned with a minimal 3" threshold. Valley's acrylic shower bases are made at our facility in Mission, BC (Canada) out of high gloss, crack-resistant acrylic. Complies with CSA & IAPMO standards.

CUSTOMIZE YOUR SHOWER BASE

ALL UPCHARGE OPTIONS ARE MADE TO ORDER - NO REFUND - NO RETURN -

AVAILABLE CUSTOMIZATION OPTIONS	MODEL No.
TEXTURED BOTTOM	C4
DOUBLE TILING FLANGE	C5
TEXTURED BOTTOM + DOUBLE TILING FLANGE	C45

DESCRIPTION:
<ul style="list-style-type: none"> • Single Threshold / Opening • White Finish • Off set Drain • High gloss / Crack-resistant acrylic. • Made in Canada. • Complies with CSA & IAPMO standards.

SHIPPING INFORMATION:
<ul style="list-style-type: none"> <li style="width: 50%;">• Length: 68" / 1727mm <li style="width: 50%;">• Net Weight: 30 kg / 66lbs <li style="width: 50%;">• Width: 34" / 864mm <li style="width: 50%;">• Gross Weight: 35 kg / 77lbs <li style="width: 50%;">• Height: 8" / 203mm

SSTOD6630L1
(LEFT HAND DRAIN LOCATION)

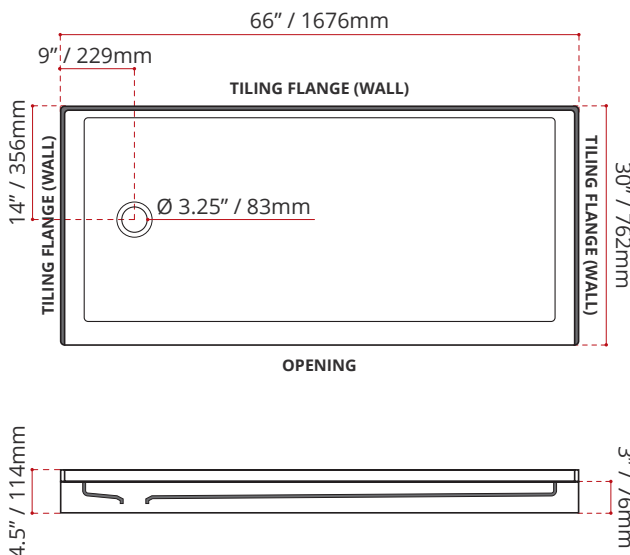

SSTOD6630R1
(RIGHT HAND DRAIN LOCATION)

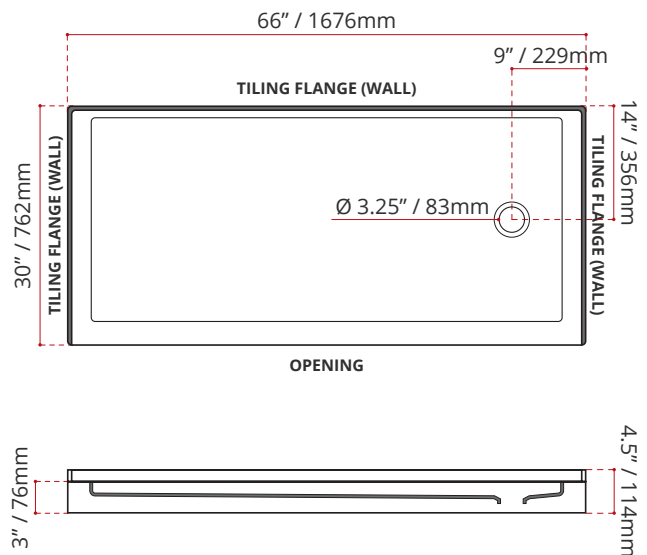

DISCLAIMER: Measurements may vary ±1/4" (Diagram Not to scale)

